

## Sword Series LED Tri-Proof Lamp



Model	L(mm)	W(mm)	H(mm)	N.W/PC	G.W/PC	Qty/CTN
SJG-STP-30W	600	83	63	1.5KG	2KG	4PCS/6PCS
SJG-STP-40W	900	83	63	2.2KG	2.7KG	4PCS/6PCS
SJG-STP-60W	1200	83	63	2.8KG	3.4KG	4PCS/6PCS
SJG-STP-80W	1500	83	63	3.5KG	4.2KG	4PCS/6PCS

## Sword Series LED Tri-Proof Lamp

---

### GENERAL DESCRIPTION

Incredibly durable and long lasting, this SJ Green's Sword series LED Tri-Proof light is perfect for use in warehouses, shopping outlets, hotels and offices. It's water, dust, corrosion and pressure proof, which is why it's earned an impressive IP65 rating.

Safety is assured thanks to excellent heat dissipation features, and with no mercury content, this light is eco-friendly as well as being super-efficient. With quality in mind, it features a high-tech, patented optical design, making it a lighting feature you can trust to perform - especially with a 50,000 hour life-expectancy behind it.

It comes with 120lm/w of light, offering enhanced brightness in your warehouse or business for customers and staff alike. And it has important CE, RoHS and TUV certification to give you extra peace of mind.

### APPLICATION

- Warehouse Lighting
- Factory Lighting
- Convention Center Lighting
- Retail Lighting
- Showroom Lighting
- Area & Storage Lighting
- Office Lighting

### STRUCTURE, MATERIALS, & FEATURES

- Die cast aluminum housing construction.
- Corrosion resistant electro coat dark grey finish (custom colors available).
- Frosted polycarbonate lens for even glow illumination.
- Hanging mount accessories included.
- High power factor, low THD driver
- Instant-On flicker-free Cold Start and Hot Re-Start.
- Bright white light for greater visibility and safety.
- High Output LED's.
- Up to 15 year maintenance free operation.
- 5 Year Warranty on complete fixture. (LED's, Driver, & Housing)
- Optional: 0-10V Dimming

## Sword Series LED Tri-Proof Lamp

### SPECIFICATIONS

Model	SJG-STP-30W	SJG-STP-40W	SJG-STP-60W	SJG-STP-80W
Dimension	600X83X63mm	900X83X63mm	1200X83X63mm	1500X83X63mm
Power	30W	40W	60W	80W
LEDs	Samsung SMD2835	Samsung SMD2835	Samsung SMD2835	Samsung SMD2835
Driver	TUV/UL Approved Driver	TUV/UL Approved Driver	TUV/UL Approved Driver	TUV/UL Approved Driver
Input Voltage	100-240V / 50-60Hz	100-240V / 50-60Hz	100-240V / 50-60Hz	100-240V / 50-60Hz
PF	>0.95	>0.95	>0.95	>0.95
Luminous Efficiency	110lm/w-120lm/w	110lm/w-120lm/w	110lm/w-120lm/w	110lm/w-120lm/w
Dimming(option)	0-10V	0-10V	0-10V	0-10V
CRI	>80	>80	>80	>80
CCT	3000K-6500K	3000K-6500K	3000K-6500K	3000K-6500K
IP Grade	IP65	IP65	IP65	IP65
Operating temp.	-40°C~+50°C	-40°C~+50°C	-40°C~+50°C	-40°C~+50°C
Total Harmonic Distortion	<20%	<20%	<20%	<20%
Lifespan	>50,000hs	>50,000hs	>50,000hs	>50,000hs
Warranty	5 Year	5 Year	5 Year	5 Year

### LUMINOUS INTENSITY DISTRIBUTION

#### SJG-STP-30W

LUMINOUS INTENSITY DISTRIBUTION

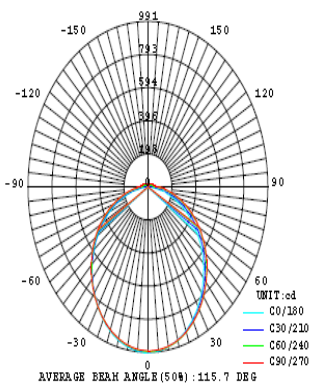

LUMINOUS INTENSITY DISTRIBUTION

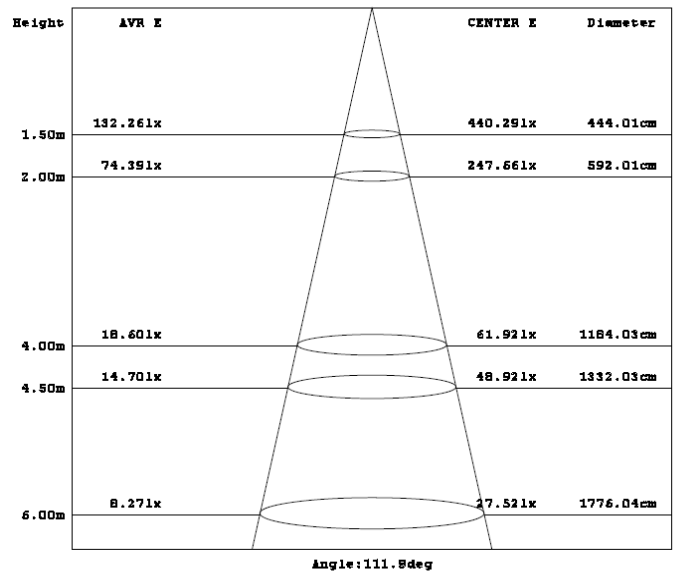
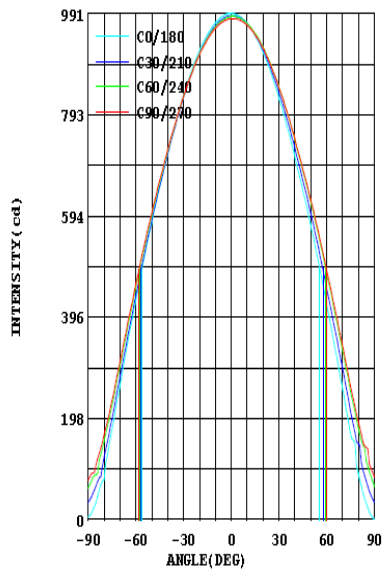

# Sword Series LED Tri-Proof Lamp

## SJG-STP-40W

LUMINOUS INTENSITY DISTRIBUTION

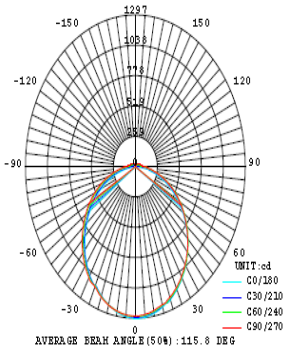

LUMINOUS INTENSITY DISTRIBUTION

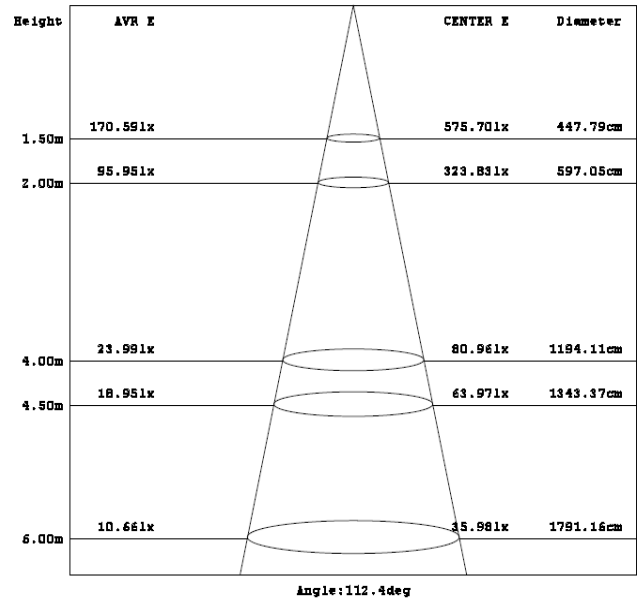
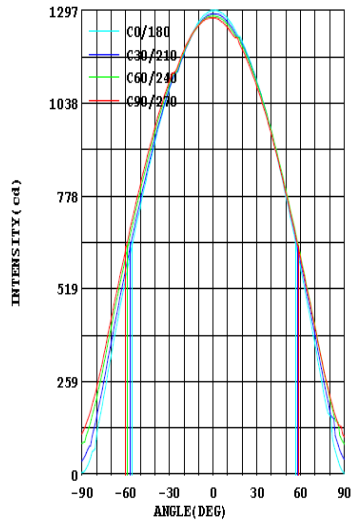

## SJG-STP-60W

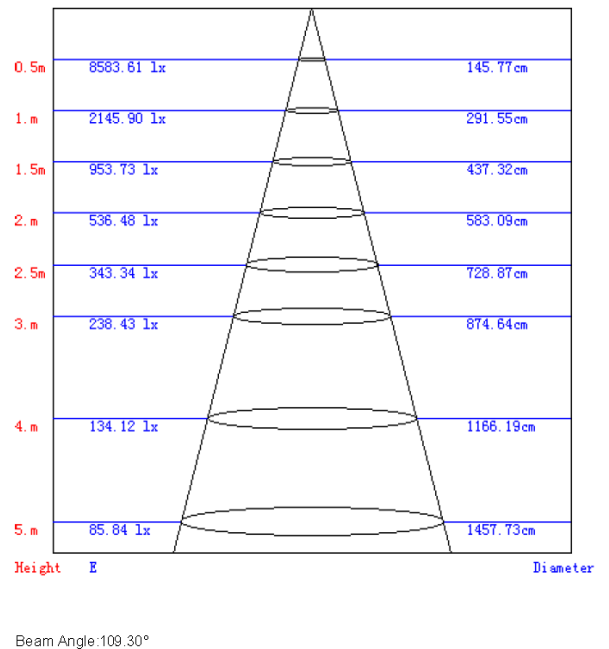
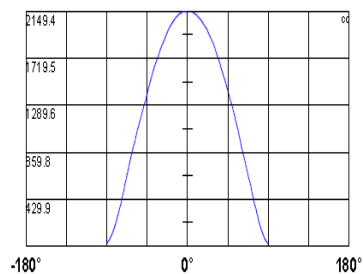
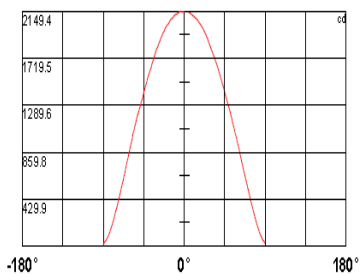
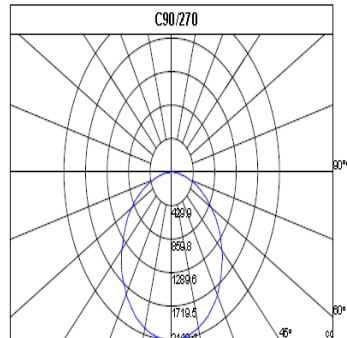
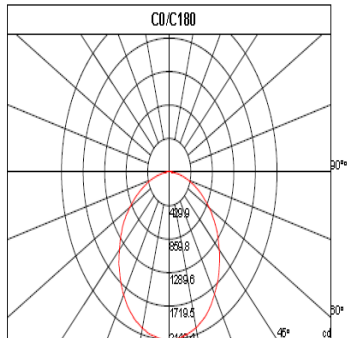

## Sword Series LED Tri-Proof Lamp

### SJG-STP-80W

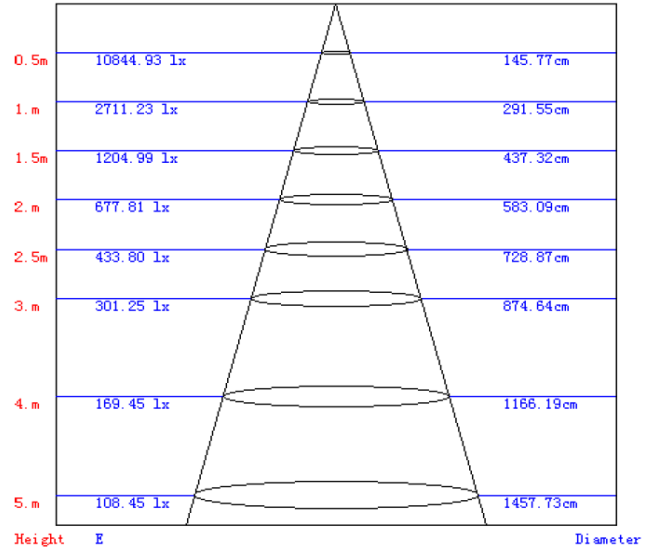
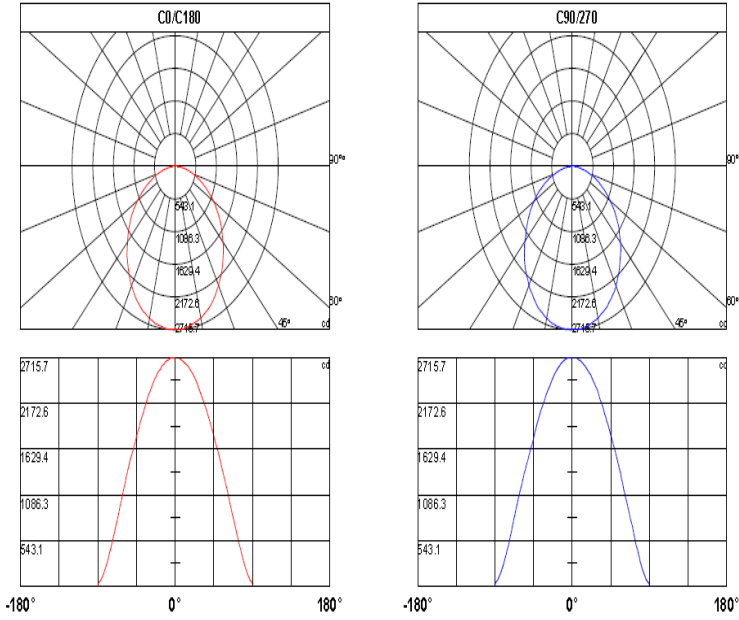

### GALLERY

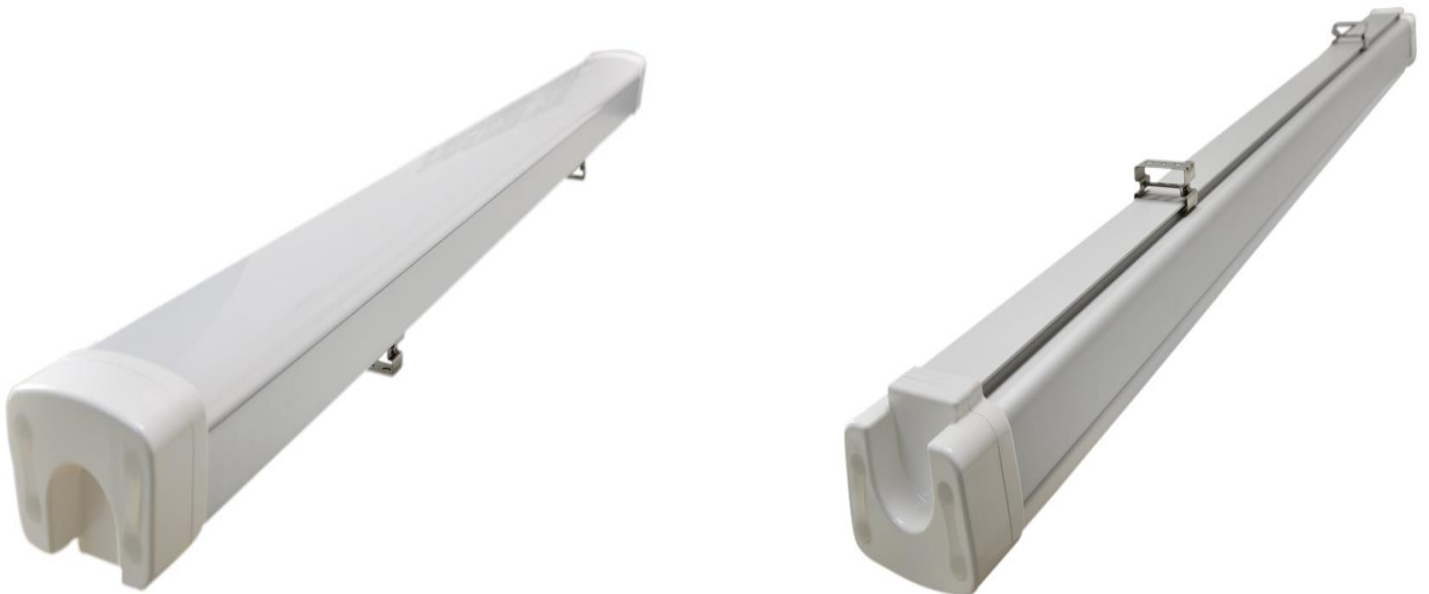

## Sword Series LED Tri-Proof Lamp

### INSTALLATION

#### 1) Ceiling mounting

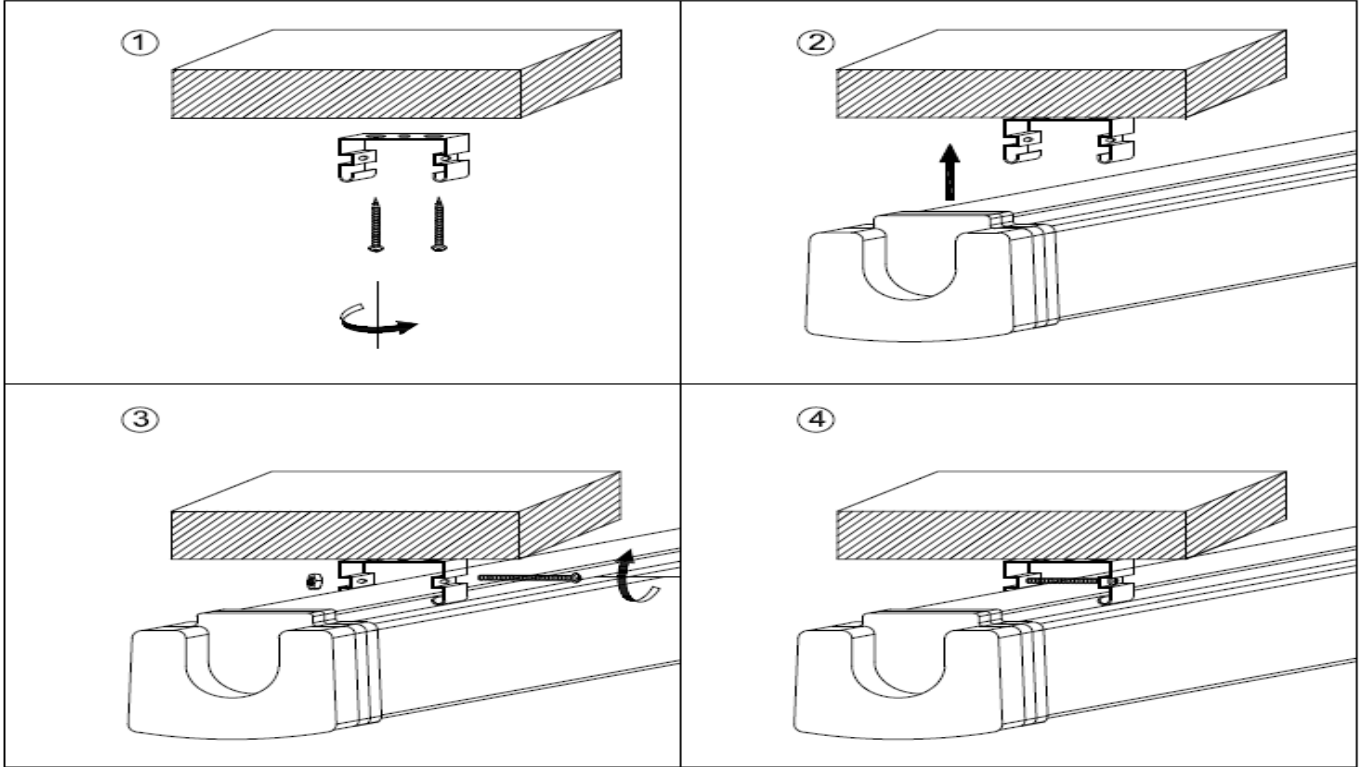

#### 2) Hanging kits

